

Newloc® Brass

Brass Push-to-Connect Fittings



Celebrating
55
Years
of Service
1954-2009

ESOP Employee Owned
for Your Benefit

NEWAGE
INDUSTRIES

Fluid Transfer Specialists®

Brass Push-To-Connect Fittings



- Extremely easy to install — no tools necessary
- Made of durable brass — elbows and tees are forged
- Much higher temperature/pressure ratings than that of plastic Newloc
- No flow restrictions
- All male pipe threads come with a pre-applied fluoropolymer sealant
- Easy to disconnect and reuse



Installation Instructions:



1. Cut tubing cleanly at 90° angle and push into collet



2. Installation complete and secure



3. To disconnect push in collet and pull tubing

Notes

Construction materials:

Body & Collet: Brass
'O'- Ring: Buna-N (other materials available)

Working pressure:

Limited only by the working pressure of the plastic tubing used up to 250 psi**

Vacuum rating:

Full** (29.9 in./Hg)

Working temperature:

-10°F to 200°F** (higher temperatures are possible with special 'O'-rings — call for details)

**Values listed are typical for the material used in manufacture, except where noted, and are meant only as a guide to aid in design. Field testing should be performed to find the actual values for your application.

Use NEWLOC BRASS fittings with all types of semi-rigid to rigid plastic tubing including nylon and polyethylene. They may also be used with limited soft tubing sizes using tube supports (available). Pulling on the inserted tubing or increasing the pressure actually tightens the seal.

Typical applications include systems for pneumatic control, robotics, instrumentation, and chemicals.

Manifolds pre-mounted with NEWLOC BRASS fittings or nickel-plated NEWLOC BRASS (for improved aesthetics) are available — call for details.

All male pipe threads come with a pre-applied sealant of fluoropolymer, however for subsequent use it is recommended that sealant, such as PTFE Thread Sealant be used. The push-to-connect fitting ends are self-sealing — do not use sealants at this connection.

If tube disconnection is performed, it may be necessary to re-cut the end of the tubing to ensure perfect sealing when reattached.

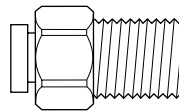

Male Adapter

PART NO.	TUBE OD (IN.) x THREAD
620 0103	1/8 x 1/16 NPTF
620 0110	1/8 x 1/8 NPTF
620 0012*	1/8 x 10-32 UNF
620 0145	5/32 x 1/8 NPTF
620 0159	5/32 x 1/4 NPTF
620 0019*	5/32 x 10-32 UNF
620 0026*	3/16 x 10-32 UNF
620 0243	1/4 x 1/8 NPTF
620 0257	1/4 x 1/4 NPTF
620 0271	1/4 x 3/8 NPTF
620 0033*	1/4 x 10-32 UNF
620 0369	3/8 x 1/8 NPTF
620 0383	3/8 x 1/4 NPTF
620 0397	3/8 x 3/8 NPTF
620 0404	3/8 x 1/2 NPTF
620 0439	1/2 x 1/4 NPTF
620 0446	1/2 x 3/8 NPTF
620 0453	1/2 x 1/2 NPTF

*Gasket supplied

All items sold in increments of 5 pieces.

Brass Push-To-Connect Fittings

Union 90° Elbow

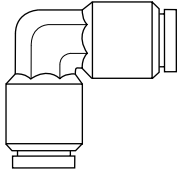

PART NO.	TUBE OD (IN.)
620 5738	1/8
620 5745	5/32
620 5759	1/4
620 5773	3/8
620 5780	1/2

Swivel Female 90° Elbow

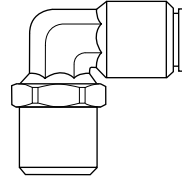

PART NO.	TUBE OD (IN.) x FNPT
620 5479	5/32 x 1/8
620 5521	1/4 x 1/8
620 5528	1/4 x 1/4
620 5591	3/8 x 1/4
620 5619	1/2 x 3/8

Swivel Male 90° Elbow

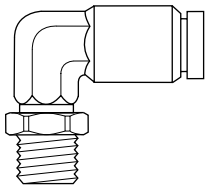

PART NO.	TUBE OD (IN.) x THREAD
620 4527	1/8 x 1/8 NPTF
620 4548	5/32 x 1/8 NPTF
620 4555	5/32 x 1/4 NPTF
620 4443*	5/32 x 10-32 UNF
620 4569	3/16 x 1/8 NPTF
620 4590	1/4 x 1/8 NPTF
620 4597	1/4 x 1/4 NPTF
620 4604	1/4 x 3/8 NPTF
620 4457*	1/4 x 10-32 UNF
620 4653	3/8 x 1/8 NPTF
620 4660	3/8 x 1/4 NPTF
620 4667	3/8 x 3/8 NPTF
620 4674	3/8 x 1/2 NPTF
620 4688	1/2 x 3/8 NPTF
620 4695	1/2 x 1/2 NPTF

*Gasket supplied

Swivel Male Banjo 90° Elbow

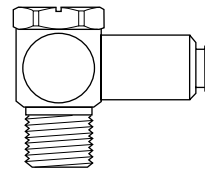

PART NO.	TUBE OD (IN.) x THREAD
620 4814*	5/32 x 10-32 UNF

*Gasket supplied

Union Connector

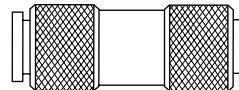

PART NO.	TUBE OD (IN.)
620 1566	1/8
620 1573	5/32
620 1587	1/4
620 1601	3/8
620 1608	1/2

Male 90° Elbow

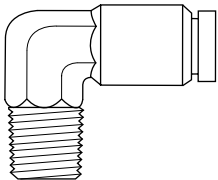

PART NO.	TUBE OD (IN.) x NPTF
620 4156	1/8 x 1/8
620 4177	5/32 x 1/8
620 4198	3/16 x 1/8
620 4219	1/4 x 1/8
620 4226	1/4 x 1/4
620 4233	1/4 x 3/8
620 4282	3/8 x 1/8
620 4289	3/8 x 1/4
620 4296	3/8 x 3/8
620 4310	1/2 x 1/4
620 4317	1/2 x 3/8
620 4324	1/2 x 1/2

Reducing Union Connector

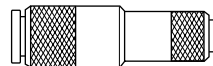

PART NO.	TUBE OD x TUBE OD (IN.)
620 1804	3/8 x 1/4

Female 90° Elbow

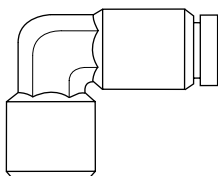

PART NO.	TUBE OD (IN.) x FNPT
620 5178	1/8 x 1/8
620 5199	5/32 x 1/8
620 5241	1/4 x 1/8
620 5248	1/4 x 1/4
620 5311	3/8 x 1/4

Female Adapter

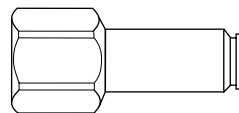

PART NO.	TUBE OD (IN.) x FNPTF
620 2987	1/8 x 1/8
620 3022	5/32 x 1/8
620 3120	1/4 x 1/8
620 3134	1/4 x 1/4
620 3246	3/8 x 1/4
620 3260	3/8 x 3/8

All items sold in increments of 5 pieces.

Brass Push-To-Connect Fittings

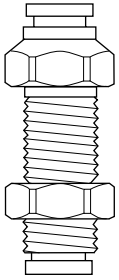

Bulkhead Union

PART NO.	TUBE OD (IN.)
620 3526	1/8
620 3533	5/32
620 3547	1/4
620 3561	3/8
620 3568	1/2

Plug†

PART NO.	STEM OD (IN.)
620 9133	1/8
620 9140	5/32
620 9154	1/4
620 9168	3/8
620 9175	1/2

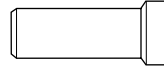

†Constructed of molded nylon

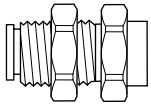

Female Bulkhead Union

PART NO.	TUBE OD (IN.) x FNPTF
620 3743	1/4 x 1/8
620 3757	1/4 x 1/4
620 3862	3/8 x 1/4

4-Way Union Connector

PART NO.	TUBE OD (IN.)
620 2903	1/8
620 2924	1/4
620 2938	3/8

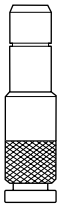
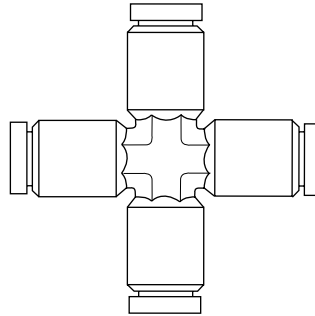

Reducer

PART NO.	STEM OD x TUBE OD (IN.)
620 8881	1/4 x 1/8
620 8888	1/4 x 5/32
620 8937	3/8 x 1/4

Union 'Y' Connector

PART NO.	BRANCH TUBE OD x STEM OD (IN.)
620 2301	5/32 x 5/32
620 2364	1/4 x 5/32
620 2378	1/4 x 1/4

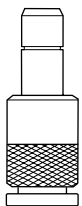
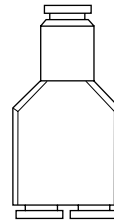

Expander

PART NO.	STEM OD x TUBE OD (IN.)
620 9021	5/32 x 1/4
620 9070	1/4 x 3/8

Male 'Y' Adapter

PART NO.	BRANCH TUBE OD (IN.) x STEM NPTF
620 1986	5/32 x 1/8
620 2070	1/4 x 1/4

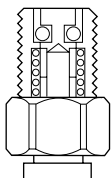
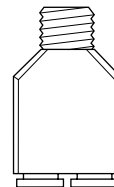

Male Adapter, Quick Disconnect with automatic shutoff

PART NO.	TUBE OD (IN.) x NPTF
620 1216	1/4 x 1/8
620 1230	1/4 x 1/4

All items sold in increments of 5 pieces.

Brass Push-To-Connect Fittings

Union Tee

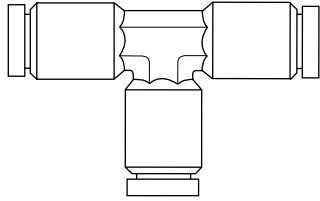

PART NO.	TUBE OD (IN.)
620 6508	1/8
620 6515	5/32
620 6522	3/16
620 6529	1/4
620 6543	3/8
620 6550	1/2

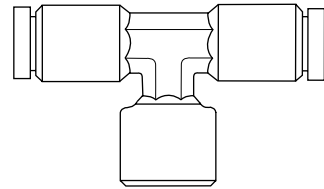

Female Branch Tee

PART NO.	TUBE OD (IN.) x STEM FNPTF
620 8090	1/4 x 1/8
620 8125	3/8 x 1/4

Male Branch Tee

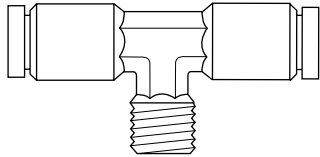

PART NO.	TUBE OD (IN.) x STEM NPTF
620 7418	1/8 x 1/8
620 7439	5/32 x 1/8
620 7460	3/16 x 1/8
620 7481	1/4 x 1/8
620 7488	1/4 x 1/4
620 7544	3/8 x 1/8
620 7551	3/8 x 1/4
620 7558	3/8 x 3/8
620 7586	1/2 x 3/8

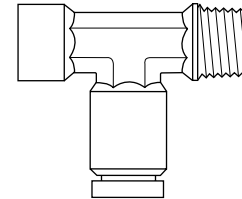

Female/Male Run Tee

PART NO.	FNPTF x MNPTF x STEM TUBE OD (IN.)
620 8363	1/8 x 1/8 x 1/4

Swivel Male Branch Tee

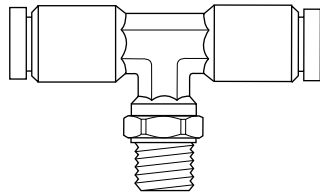

PART NO.	TUBE OD (IN.) x STEM THREAD
620 7705*	5/32 x 10-32 UNF
620 7852	1/4 x 1/8 NPTF
620 7859	1/4 x 1/4 NPTF
620 7922	3/8 x 1/4 NPTF
620 7929	3/8 x 3/8 NPTF
620 7957	1/2 x 3/8 NPTF
620 7964	1/2 x 1/2 NPTF

*Gasket supplied

Male Run Tee

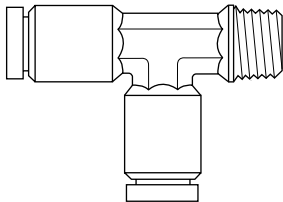

PART NO.	TUBE OD (IN.) x BRANCH NPTF
620 6676	1/8 x 1/8
620 6697	5/32 x 1/8
620 6739	1/4 x 1/8
620 6746	1/4 x 1/4
620 6802	3/8 x 1/8
620 6809	3/8 x 1/4
620 6816	3/8 x 3/8

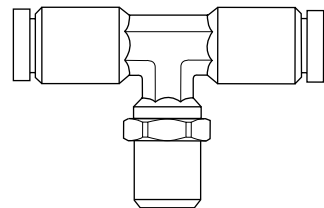

Swivel Female Branch Tee

PART NO.	TUBE OD (IN.) x STEM FNPTF
620 8181	1/4 x 1/8

Swivel Male Run Tee

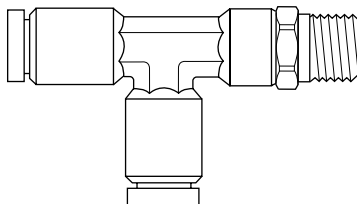

PART NO.	TUBE OD (IN.) x BRANCH THREAD
620 7047	1/8 x 1/8 NPTF
620 7068	5/32 x 1/8 NPTF
620 7110	1/4 x 1/8 NPTF
620 7117	1/4 x 1/4 NPTF
620 7180	3/8 x 1/4 NPTF
620 7187	3/8 x 3/8 NPTF
620 7215	1/2 x 3/8 NPTF
620 7222	1/2 x 1/2 NPTF

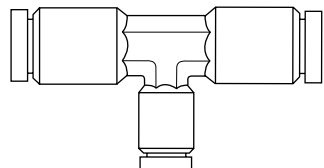

Reducing Union Tee

PART NO.	TUBE OD (IN.) x STEM OD
620 8538	3/8 x 1/4

All items sold in increments of 5 pieces.



Superthane® Pneumatic Colored Polyurethane Tubing

- Made from hydrolysis resistant, 85A durometer Ether polyurethane
- Stocked in 10 colors for easy multiple line identification
- Naturally flexible for close-in bending — contains no plasticizers which could migrate and cause tube hardening or flow contamination
- Resistant to weathering, kinking, tearing, abrasion, impact, and radiation exposure



Nylotube® Nylon-11 & Nylon-12 Tubing

- Excellent resistance to flexural fatigue, tube vibration, and movement
- Lightweight with excellent bend radii and pressure ratings
- Resists crushing, abrasion, and cracking
- Standard availability in metric sizes and colors
- Very low moisture absorption: 1.4% maximum (at 73°F)



Zelite™ Linear Low Density Polyethylene Tubing

- Made from non-toxic ingredients conforming to FDA standards
- Does not impart a taste or odor to critical streams
- Flexible, lightweight, durable
- Offers enhanced resistance to stress cracking
- Chemically inert; forms a good barrier to gases, vapors, and moisture

Request a Push-to-Connect Fittings catalog

Inside you'll find details on NewAge Industries' line of brass push-to-connect fittings in addition to acetal. Catalogs for PVC, polyurethane, silicone, rubber, fluoropolymer, and semi-rigid tubing and hose are available, as well as barbed fittings and clamps and custom products. Contact your NewAge Industries' sales representative or local distributor to request a copy of the catalog you need, or visit www.newageindustries.com.



Newloc, Superthane, Nylotube, Zelite, NewAge, "Fluid Transfer Specialists," and The "N" Logo are trademarks of NewAge® Industries, Inc.

WARRANTY: NewAge Industries' products are warranted to be free from defects in material and workmanship. Any product found to carry such defects will be replaced without charge. This warranty is limited only to the replacement of NewAge Industries' products, item for item, which after examination by NewAge Industries are deemed defective. NewAge Industries specifically disclaims any other liability. The data supplied is provided as a helpful guideline and is believed to be reliable; however, nothing stated shall constitute a guarantee, recommendation, or warranty for any application.

NOTICE: NewAge Industries, Inc. has been a privately owned corporation since 1954. Neither the corporation nor its principals are affiliated, in any way, with any other group or entity either representing themselves as or being referred to by the term New-Age.

© NewAge Industries, Inc. 2009 Specifications are subject to change without notice.

6/30/09

DISTRIBUTOR PARTNER



145 James Way
Southampton, PA 18966
www.newageindustries.com

800-50-NEWAGE
(800-506-3924)
215-526-2300

Fax: 800-837-1856
215-526-2190

info@newageindustries.com